



# UDB Training

Solution Enablement Center (SEC)

IBM CHINA

Yang Zhenghong  
e-mail: yangzh@cn.ibm.com

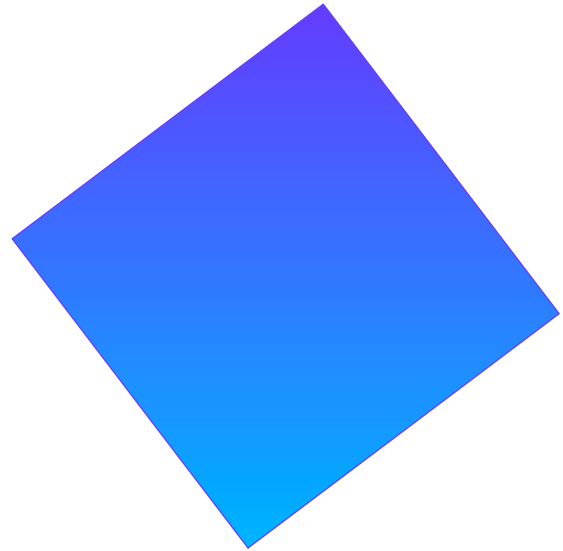

*IBM Software*

---

? IBM 1997

## *UDB Administration & Application Development*

---

- **UDB Product Overview**
- **Getting Started and Connected**
- **UDB Data Placement**
- **UDB Data Object**
- **UDB Data Management**
- **UDB Security**
- **UDB Application**
- **Integrated Tools**

*IBM Software*

---

? IBM 1997

## V6.1 Base Product Packing

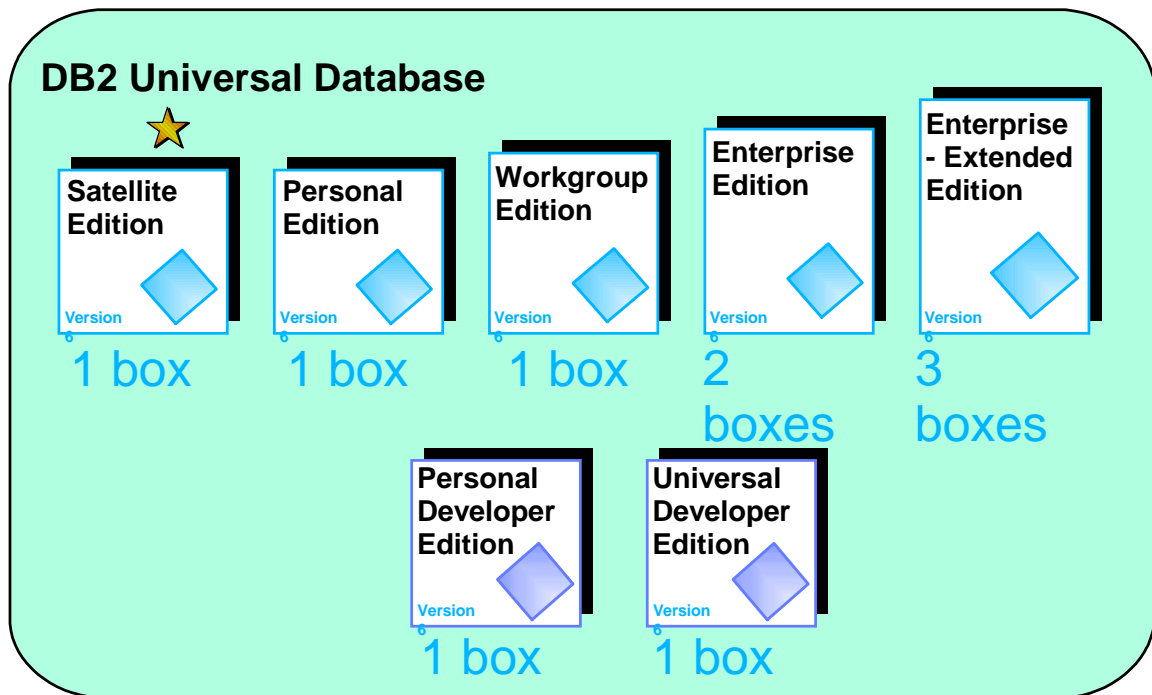

CF071102

## V6.1 Additional Product Packaging

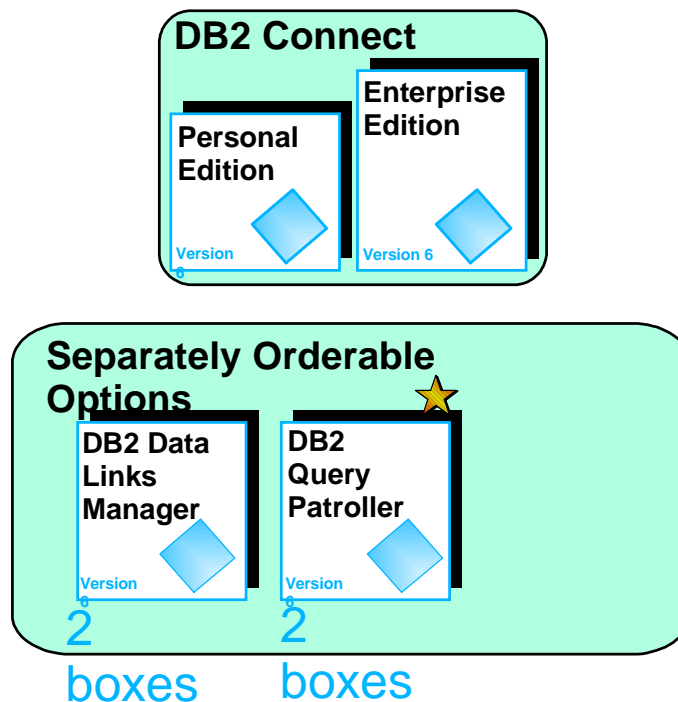

CF071103

# DB2 UDB V6.1 Server Platforms

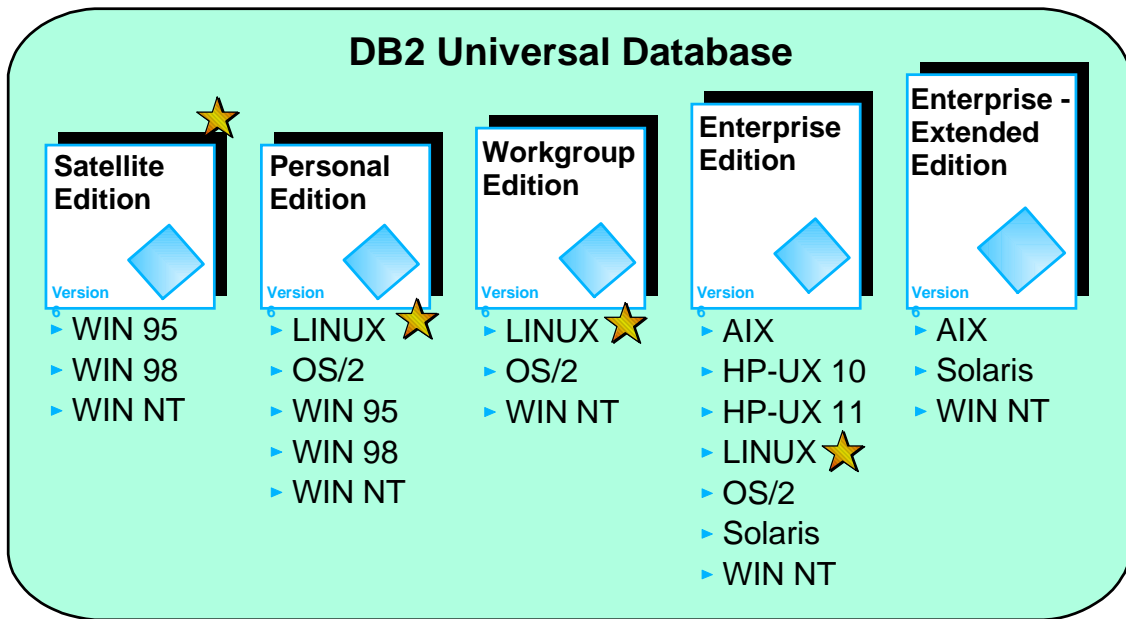

Note: DB2 Satellite Edition will ship as 6.1 but after GA, date TBD

CF071104

# DB2 Products

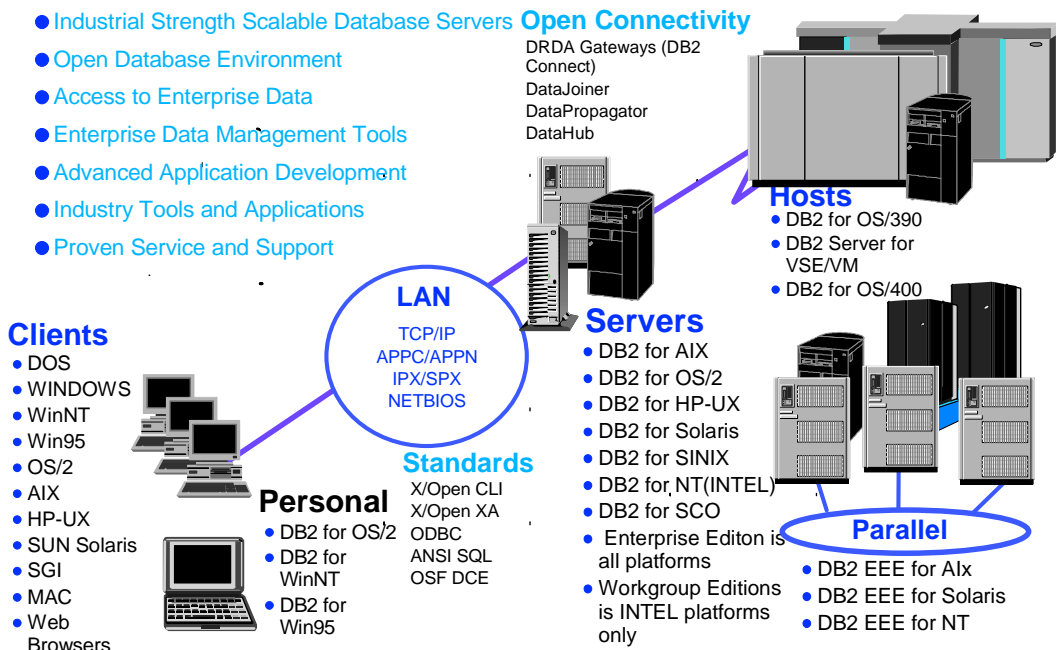

# DB2 UDB for LINUX

## Robust Enterprise Database Server for LINUX

- Support for Personal, Workgroup and Enterprise Editions
- Includes DB2 Connect for LINUX for host connectivity
- Full technical support available

## Support for major Linux Distributions worldwide

- Caldera Systems Inc.
- Pacific HiTech Inc.
- Red Hat Software Inc.
- SuSE Holding AG

## Includes full DB2 UDB Web Support

- JDBC, SQLJ, Java Stored Procedures and User Defined Functions
- Web Control Center

## Free DB2 UDB Personal Developer's Edition

- Only free on LINUX

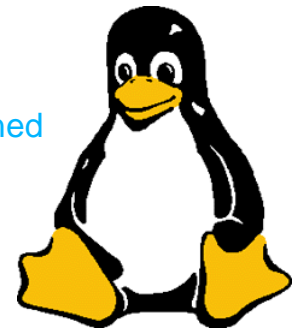

CF071105

h

# DB2 UDB V6.1 Client and SDK Platforms

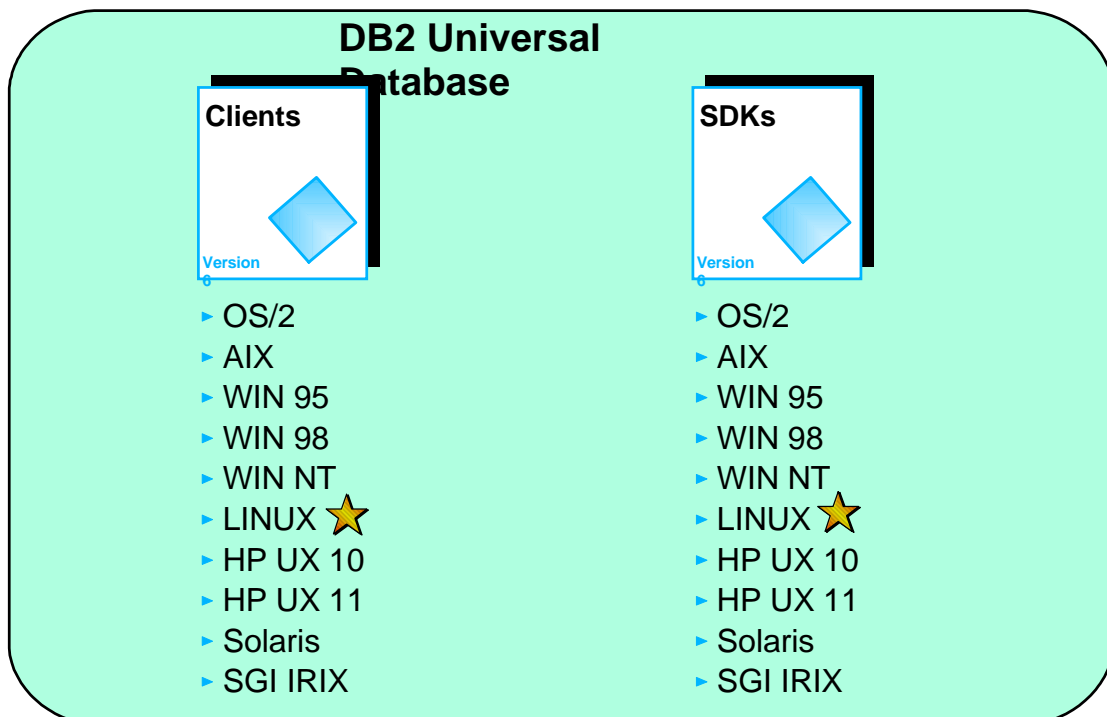

CF071106

## V6.1 DB2 UDB Client Types

### Runtime Client

- ability to access DB2 databases

### Administration Client

- ability to access DB2 databases
- ability to administer DB2 databases with GUI tools
- included as a component with all DB2 Universal Database and Connect product packages

### SDK Client

- application development environment
- ability to access DB2 databases
- optional ability to administer DB2 databases with GUI tools

- All remote applications that are not Java applets must have a DB2 client installed on client machine before they can access the remote database

- "No CAE in V6"

CF071107

## Non V6.1 Level Clients

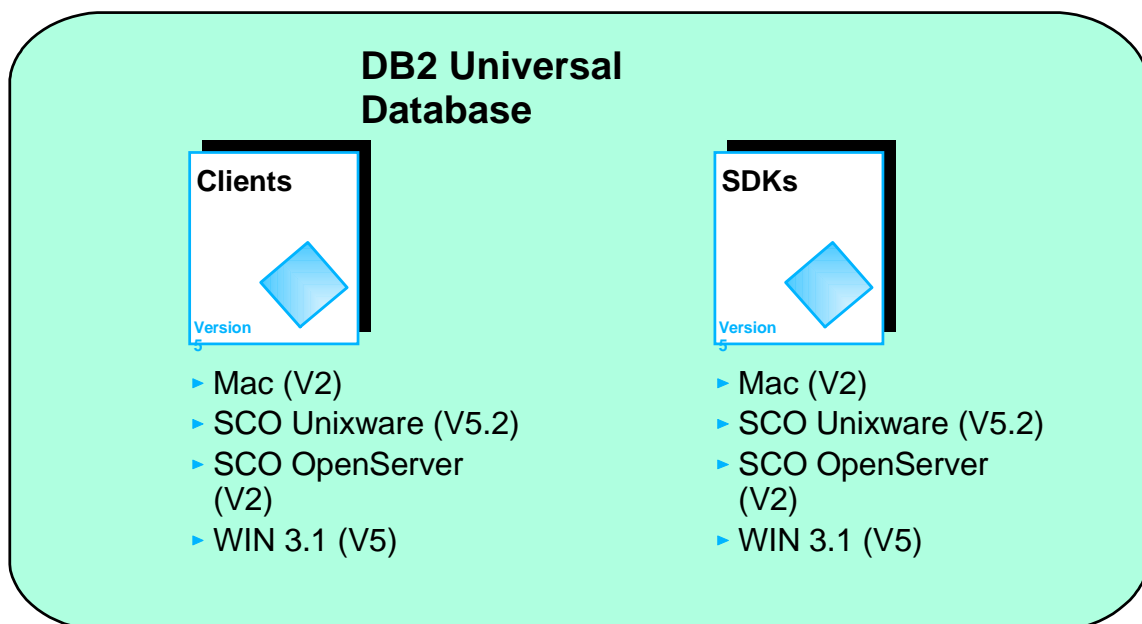

Note: All clients and SDKs are available from the web

CF071108

## DB2 UDB V6.1 Development Platforms

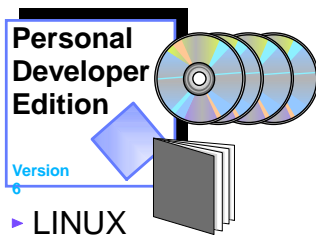

- Version 6
- ▶ LINUX
  - ▶ OS/2
  - ▶ WIN 95
  - ▶ WIN 98
  - ▶ WIN NT



- Version 6
- ▶ AIX
  - ▶ HP-UX
  - ▶ LINUX
  - ▶ OS/2
  - ▶ SGI  
IRIX
  - ▶ Solaris
  - ▶ WIN 95
  - ▶ WIN 98
  - ▶ WIN NT

CF071109

## DB2 UDB V6.1 Optional Feature Platforms

### DB2 Universal Database Optional Features



- Version 6
- ▶ UNIX
  - ▶ AIX



- Version 6
- ▶ Windows
  - ▶ WIN NT



- Version 6
- ▶ UNIX
  - ▶ AIX
  - ▶ Solaris

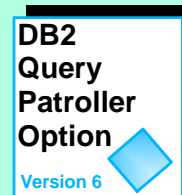

- Version 6
- ▶ Windows
  - ▶ WIN NT

Note: DB2 QP for NT will ship as 6.1 but after GA, date TBD

CF071110

# DB2 Connect V6.1 Platforms

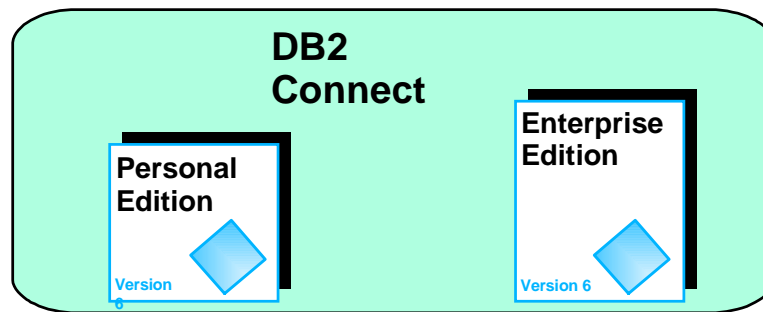

- ▶ LINUX
- ▶ OS/2
- ▶ WIN 95
- ▶ WIN 98
- ▶ WIN NT

- ▶ AIX
- ▶ HP-UX
- ▶ LINUX
- ▶ OS/2
- ▶ Solaris
- ▶ WIN NT

CF071111

# Accessing DB2

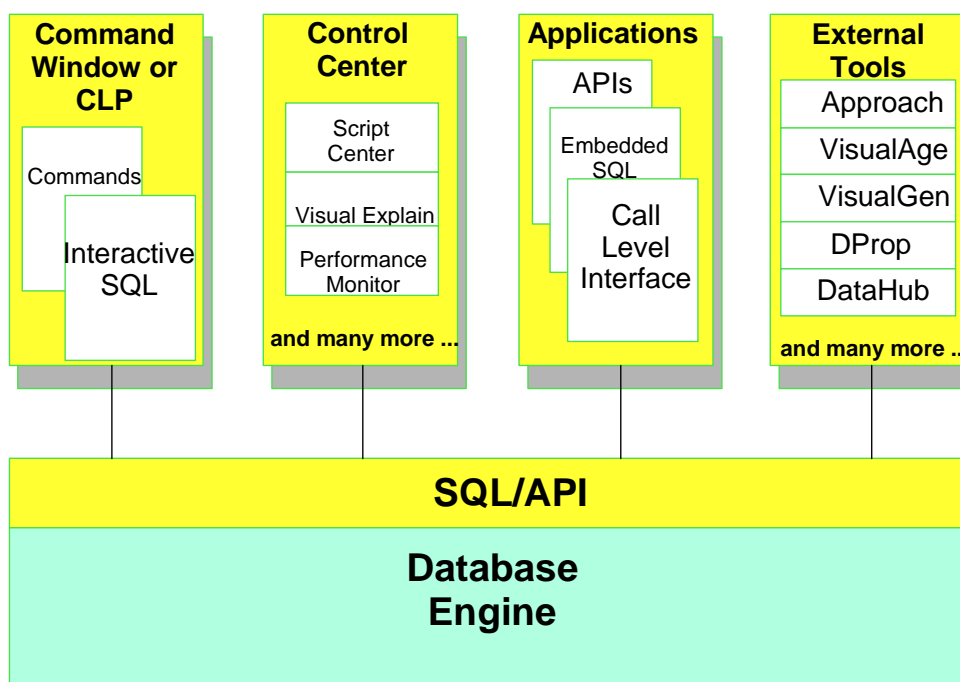

# DB2 Product Support

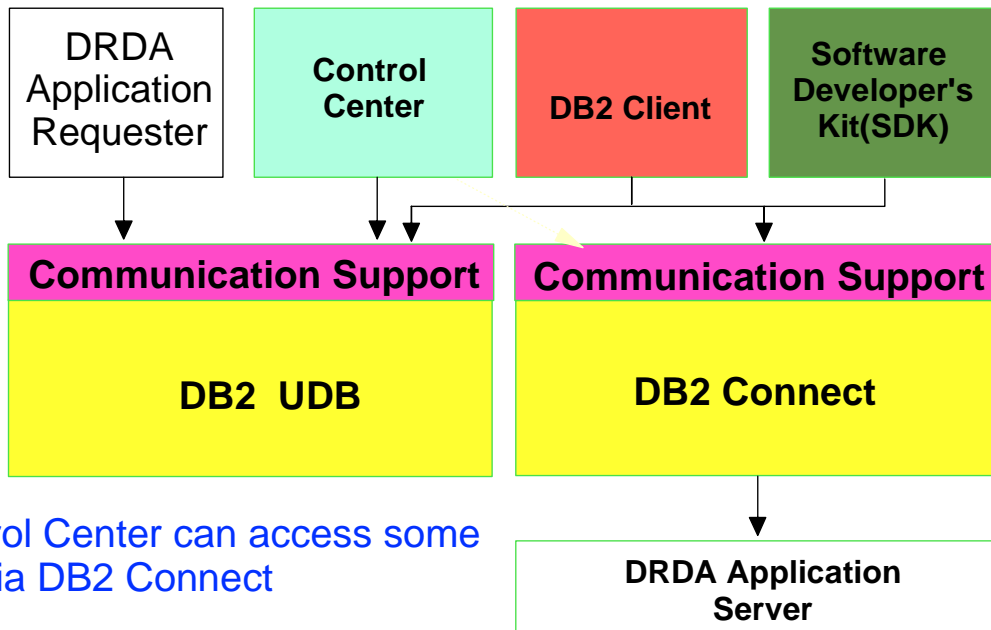

# DB2 Workgroup & Enterprise Edn.

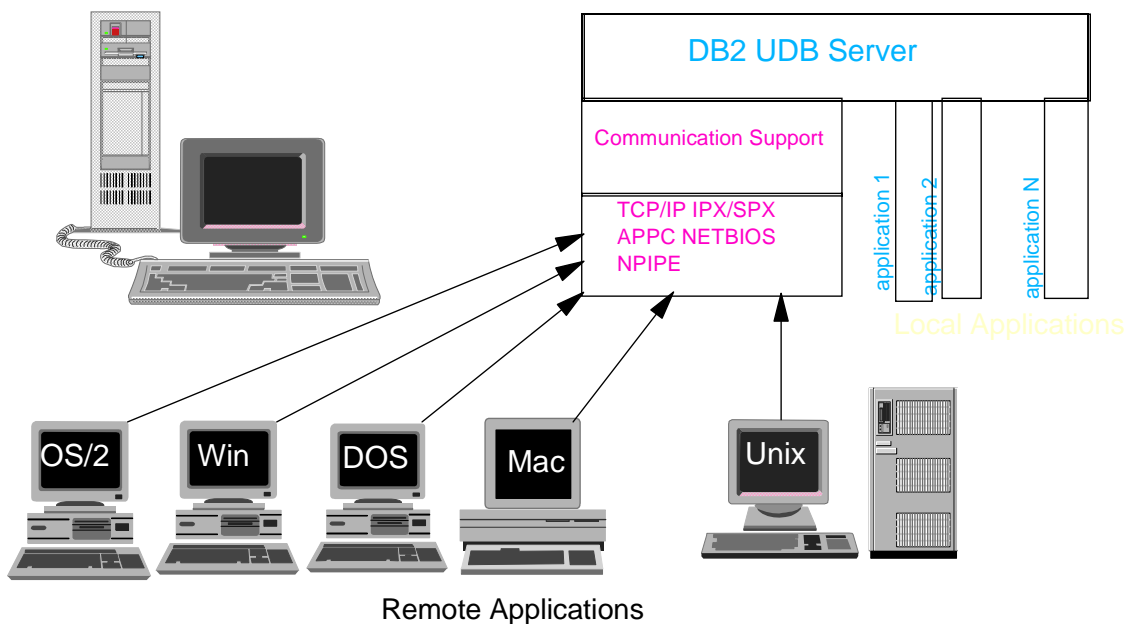



# DB2 Connect Enterprise Edition

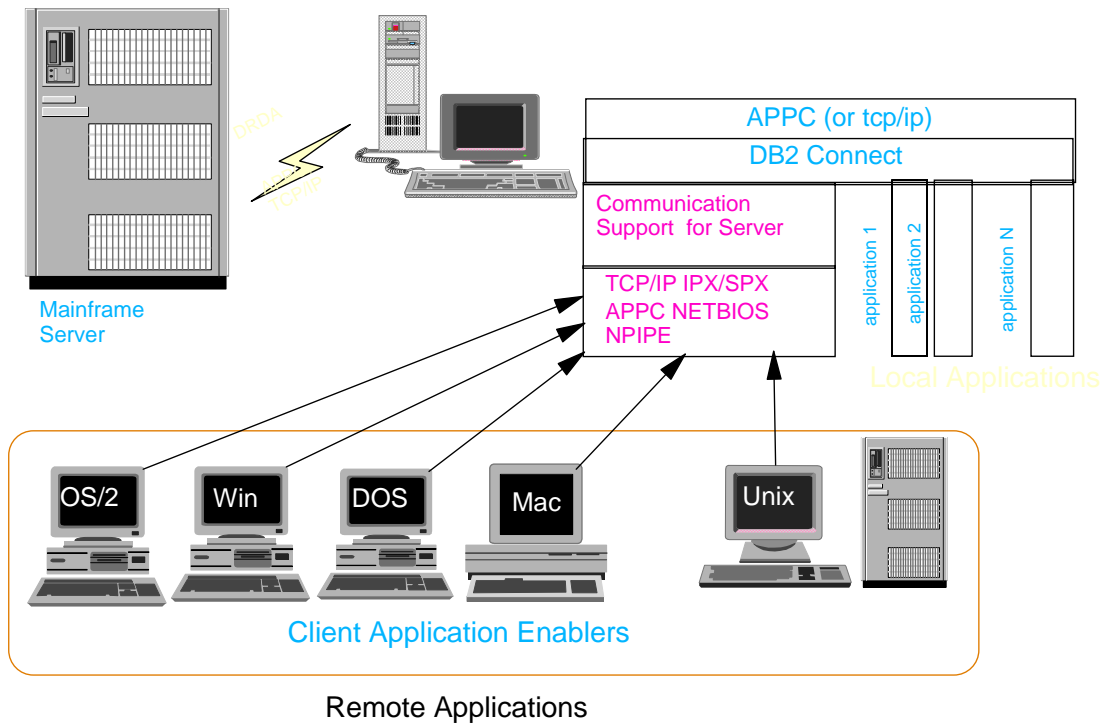

# DRDA Flow with DB2 Connect Enterprise Edn.

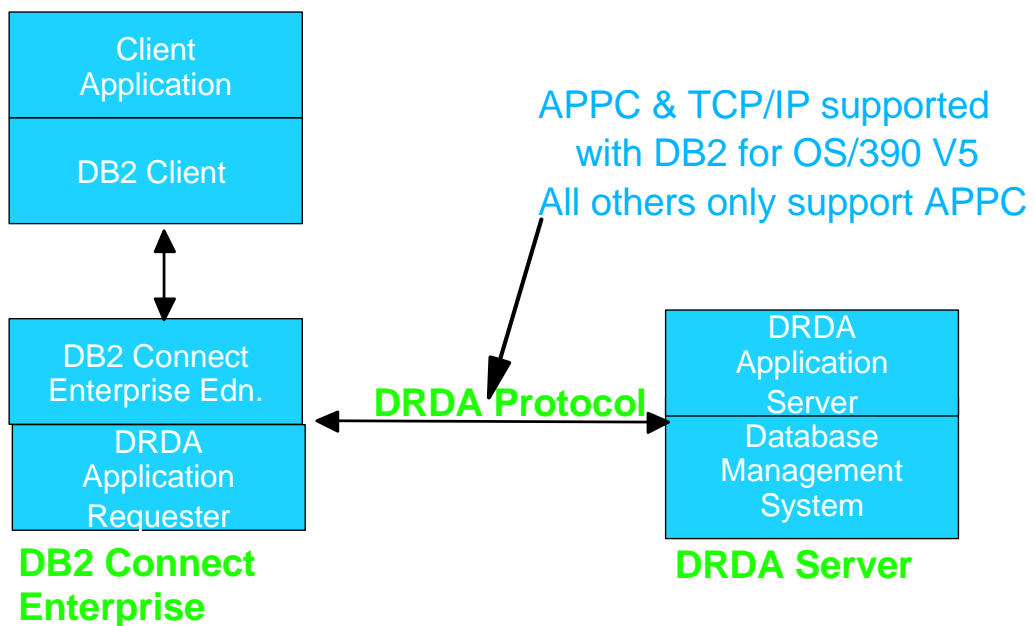

# CAE Flow

